

SOLENOID PUMPS

EKS17

TECHNICAL DATA



DIMENSIONS

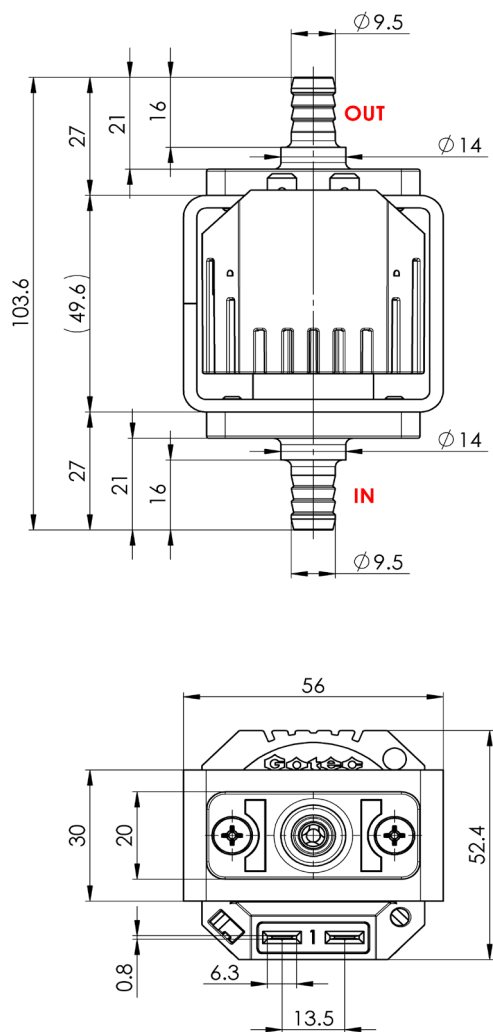

NOMINAL RATED DATA

Max. pressure	1.9[bar]	
Max. flow rate	120[l/h]	
Max. suction height	3[m]	
Viscosity range	1..600[mm ² /s]	
Filter	Mesh 100	
Tension	230[V] (24, 110V)	
Frequency	50, 60[Hz]	
Electrical connection	2 x 6.3 x 0.8 [mm]	
Power	40[W]	
Weight	~430[g]	
Temperature	1...50[°C]	
Insulation	Classe H Classe 2	100% ED / 20 [°C]

SOLENOID PUMPS

EKS17 230V

TECHNICAL DATA



PERFORMANCES

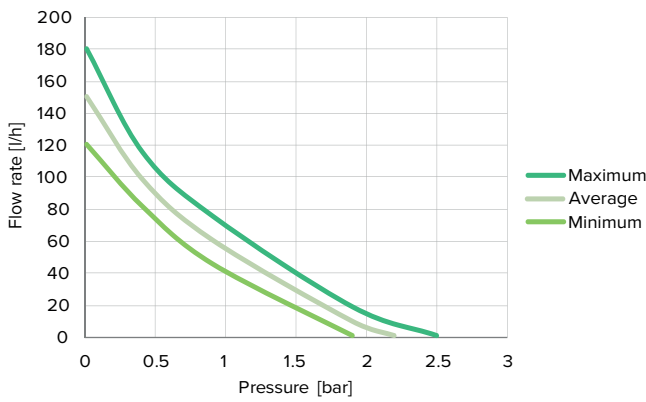

FLOW RATE & TEMPERATURE

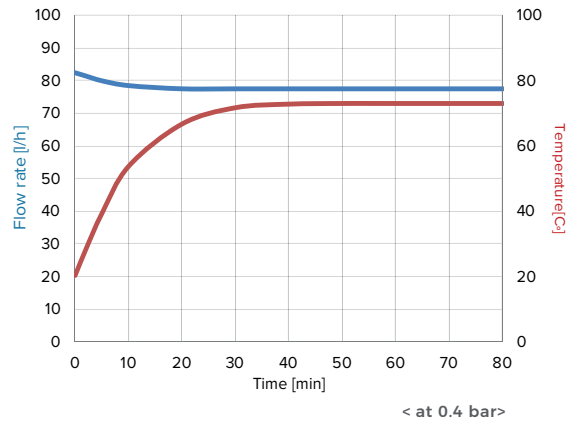

Tested with 20°C of water at ambient temperature

ACCESSORIES

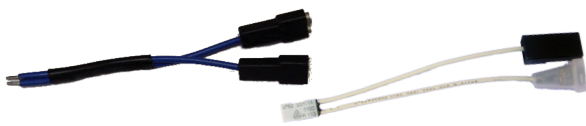

Cable with a diode

Thermal security

Large choice of materials & options

ELECTRIC WIRING DIAGRAM

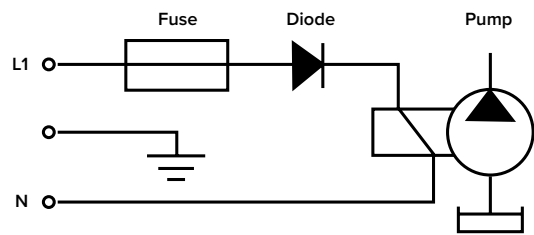

Please refer to instruction manual for more installation details. For more information, visit our website : www.gotec.ch

Certifications



SOLENOID PUMPS

EKS17 24VAC



TECHNICAL DATA

PERFORMANCES

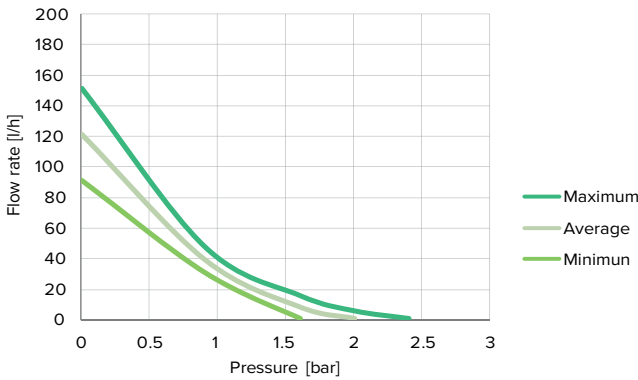

FLOW RATE & TEMPERATURE

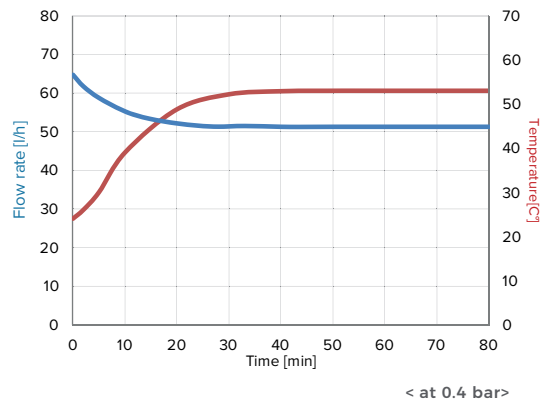

Tested with 20°C of water at ambient temperature

ACCESSORIES



Cable with a diode

Thermal security

Large choice of materials & options

ELECTRIC WIRING DIAGRAM

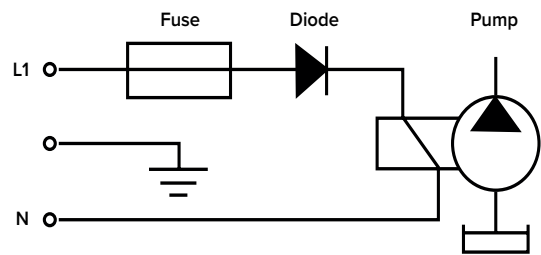

Please refer to instruction manual for more installation details. For more information, visit our website : www.gotec.ch

Certifications

